



in the office
FURNITURE

3

BENCHING

steel benching systems



A bench product is essentially rows of workspaces that are parallel to each other around a central technology infrastructure, that conveniently provides access to power and data. Users sit face-to-face or side-by-side.

Benching systems allow for variety and customization, resulting in a space saving, cost saving and productivity.

plan b benching system

three legs, three styles



The plan b benching system is aesthetically light and balanced, and delivers creative solutions to a variety of space planning and functional needs. The plan b benching system is a modular, easily configured and reconfigured product, and is manufactured and assembled using a support beam based leg system (with a choice between straight leg, closed loop leg and angled leg), with additional architectural beams for supporting reticulation trays, screening, third level storage and accessories. The plan b benching systems allow for variety and customization, resulting in space saving, cost saving and productivity.









plan b straight leg product structure



The Plan b benching system simplifies facilities management, by integrating and optimizing effectively with all types of floor spaces.

The ease of assembly / disassembly of the product, facilitates hassle - free installations, and frequent re-configurations, and creates productive working environments. The Plan b benching system has an integrated cable management facility, that delivers convenient power and data to workstations. Power and data points can be located at workstation height, or just below, for easy access.

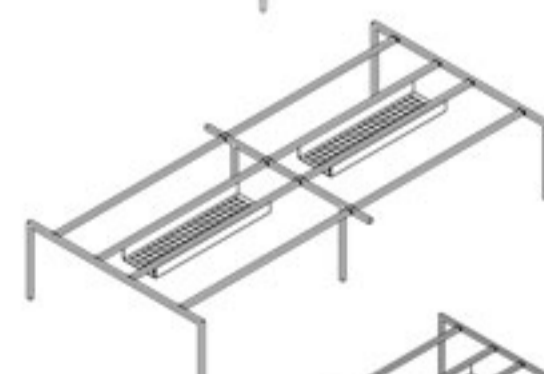
plan b straight leg product structure







	description	size	code
	desk top for single and side by side workstations with one power cut out	2000(w) x 800(d)	
	desk top for single and side by side workstations with one power cut out	1800(w) x 800(d)	
	lhs plan b single desk structure plan b single desk structure including straight leg structure including 2000(w) x 800(d), top - 22mm and power channel and power cut out	2000(w) x 800(d)	2080SR
	rhs plan b single desk structure	2000(w) x 800(d)	2080SL
	lhs plan b single desk structure straight leg structure including 1800(w) x 800(d), top - 22mm and power channel and power cut out	1800(w) x 800(d)	1880SL
	rhs plan b single desk structure	1800(w) x 800(d)	1880SR
	plan b two way side by side desk structure straight leg - leg structure including 2 x 1800/1600/1400/1200(w) - 22mm tops with 2 x power cut out and 2 x power channel	3600(w) x 800(d) 3200(w) x 800(d) 2800(w) x 800(d) 2400(w) x 800(d)	3680S 3280S 2880S 2480S
	desk top for cluster workstations with power slot	1800(w) x 800(d) 1600(w) x 800(d) 1400(w) x 800(d) 1200(w) x 800(d)	
	plan b 2 way desk structure straight leg - leg structure including 2 x 1800/1600/1400/1200(w) x 800(d) - 22m tops with 2 x power slots and 1 power tray	1800(w) x 1600(d) 1600(w) x 1600(d) 1400(w) x 1600(d) 1200(w) x 1600(d)	1816S 1616S 1416S 1216S
	plan b 4 way desk structure straight leg structure including 4 x 1800/1600/1400/1200(w) x 800(d) - 22mm tops with 4 x power slots and 2 x power trays	3600(w) x 1600(d) 3200(w) x 1600(d) 2800(w) x 1600(d) 2400(w) x 1600(d)	3616S 3216S 2816S 2416S
	plan b 6 way desk structure straight leg structure including 6 x 1800/1600/1400/1200(w) x 800(d) - 22mm tops with 6 x power slots and 3 x power trays	5400(w) x 1600(d) 4800(w) x 1600(d) 4200(w) x 1600(d) 3600(w) x 1600(d)	5416S 4816S 4216S 3616S

plan b

straight leg cluster options with desk height pedestal and single tier top filer combo

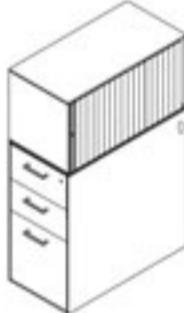

plan b straight leg - cluster options with desk height pedestal and single tier top filer combo

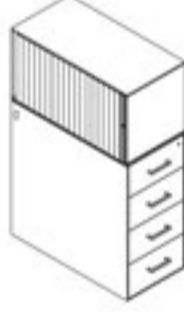
	description	size	code
	desk top for cluster workstations with power slot	refer to product structure page for desk top sizes	
	2S1F desk height pedestal - lhs with drop in pen and pencil tray with plan b handles and single tier open bookcase fixed on top of pedestal and dual power cut outs in desk height pedestal	1140(h) x 400(w) x 800(d)	1200
	2S1F desk height pedestal - rhs with drop in pen and pencil tray with plan b handles and single tier open bookcase fixed on top of pedestal and dual power cut outs in desk height pedestal	1140(h) x 400(w) x 800(d)	1300
	4S desk height pedestal - lhs with drop in pen and pencil tray with plan b handles and single tier open bookcase fixed on top of pedestal and dual power cut outs in desk height pedestal	1140(h) x 400(w) x 800(d)	1400
	4S desk height pedestal - rhs with drop in pen and pencil tray with plan b handles and single tier open bookcase and dual power cut outs in desk height pedestal	1140(h) x 400(w) x 800(d)	1500
	2S1F desk height pedestal - lhs with drop in pen and pencil tray with plan b handles and single tier roller door bookcase fixed on top of pedestal and dual power cut outs in desk height pedestal roller door available in silver and charcoal	1140(h) x 400(w) x 800(d)	S1600 C1600
	2S1F desk height pedestal - rhs with drop in pen and pencil tray with plan b handles and single tier roller door bookcase fixed on top of pedestal and dual power cut outs in desk height pedestal roller door available in silver and charcoal	1140(h) x 400(w) x 800(d)	S1700 C1700
	4S desk height pedestal - lhs with drop in pen and pencil tray with plan b handles and single tier roller door bookcase fixed on top of pedestal and dual power cut outs in desk height pedestal roller door available in silver and charcoal	1140(h) x 400(w) x 800(d)	S1800 C1800
	4S desk height pedestal - rhs with drop in pen and pencil tray with plan b handles and single tier roller door bookcase fixed on top of pedestal and dual power cut outs in desk height pedestal roller door available in silver and charcoal	1140(h) x 400(w) x 800(d)	S1900 C1900

plan b

straight leg cluster options with desk height pedestal and two tier top filer combo

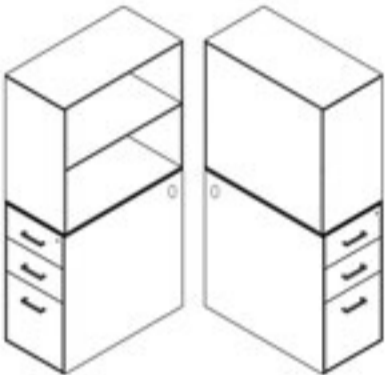
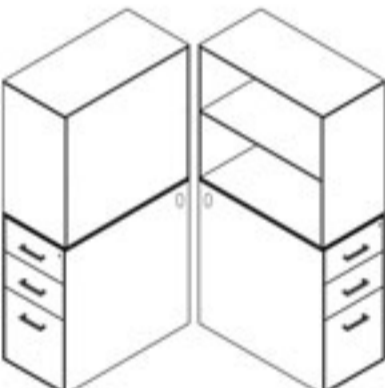
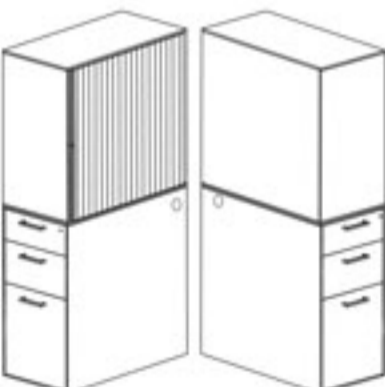
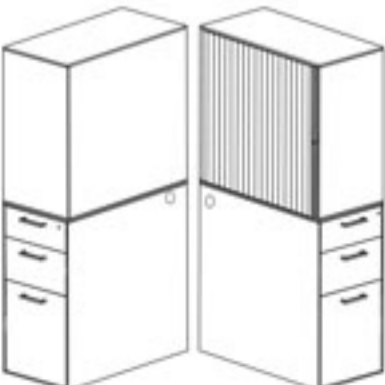

plan b straight leg - cluster options with desk height pedestal and two tier top filer combo

description	size	code
	<p>desk top for cluster workstations with power slot</p>	<p>refer to product structure page for desk top sizes</p>
	<p>2S1F desk height pedestal - lhs with drop in pen and pencil tray with plan b handles and two tier open top filer fixed on top of pedestal including laminate shelf dual power cut outs in desk height pedestal</p>	<p>1 520(h) x 400(w) x 800(d) 1150</p>
	<p>2S1F desk height pedestal - rhs with drop in pen and pencil tray with plan b handles and two tier open top filer fixed on top of pedestal including laminate shelf dual power cut outs in desk height pedestal</p>	<p>1 520(h) x 400(w) x 800(d) 1250</p>
	<p>2S1F desk height pedestal - lhs with drop in pen and pencil tray with plan b handles and two tier roller door top filer fixed on top of pedestal including laminate shelf dual power cut outs in desk height pedestal roller door available in silver and charcoal</p>	<p>1 520(h) x 400(w) x 800(d) S1350 C1350</p>
	<p>2S1F desk height pedestal - rhs with drop in pen and pencil tray with plan b handles and two tier roller door top filer fixed on top of pedestal including laminate shelf dual power cut outs in desk height pedestal roller door available in silver and charcoal</p>	<p>1 520(h) x 400(w) x 800(d) S1450 C1450</p>



plan b straight leg - open shelf side cabinet / mobile pedestals





plan b straight leg - hinge door cabinet / mobile pedestals

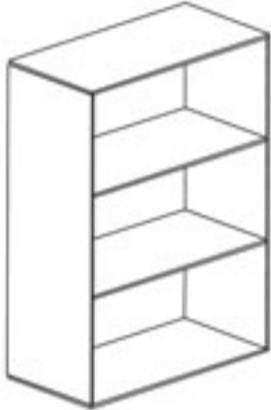

plan b straight leg - open shelf side cabinet / mobile pedestals

	<u>description</u>	<u>size</u>	<u>code</u>
	desk top for cluster workstations with power slot	refer to product structure page for desk top sizes	
	open shelf cabinet including 2 x 2/3 lamine shelves	1200(h) x 800(w) x 500(d)	500
	mobile pedestal 1S1F with drop in pen and pencil tray with plan b handles	400(w) x 525(d) x 590(h)	PB2009

plan b straight leg - hinge door cabinet / mobile pedestals

	<u>description</u>	<u>size</u>	<u>code</u>
	desk top for cluster workstations with power slot	refer to product structure page for desk top sizes	
	hinge door cabinet with plan b handles	1200(h)) x 800(w) x 500(d)	525
	mobile pedestal 3S drop in pen and pencil drawer with plan b handles	400(w) x 525(d) x 590(h)	PB2007



plan b straight leg - rollerdoor side cupboard / mobile pedestals with cushion





plan b straight leg - pigeon hole side cabinet / mobile pedestals with cushion

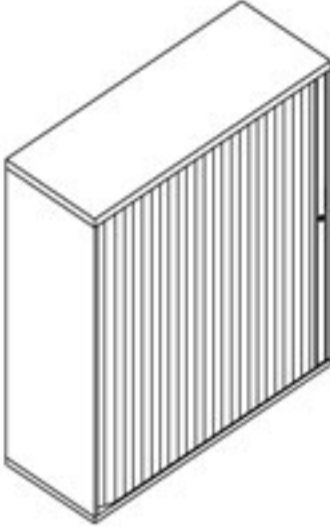

plan b straight leg - rollerdoor side cupboard / mobile pedestals with cushion

	<u>description</u>	<u>size</u>	<u>code</u>
	desk top for cluster workstations with power slot	refer to product structure page for desk top sizes	
	roller door cabinet including 2x 2/3 steel shelves roller door available in silver and charcoal	1200(h) x 800(w) x 500(d)	S600 C600
	mobile pedestal with cushion 1S1F with drop in pen and pencil tray with plan b handles and weight bearing castors	400(w) x 525(d) x 630(h)	610
	specify fabric and colour for cushion with order price includes all vulcan fabric colour		

plan b straight leg - pigeon hole side cabinet / mobile pedestals with cushion







	<u>description</u>	<u>size</u>	<u>code</u>
	desk top for cluster workstations with power slot	refer to product structure page for desk top sizes	
	pigeon hole unit with laminate dividers shelves	1200(h) x 800(w) x 500(d)	620
	mobile pedestal with cushion 3S with drop in pen and pencil tray with plan b handles and weight bearing castors	400(w) x 525(d) x 630(h)	630
	specify fabric and colour for cushion with order price includes all vulcan fabric colour		

plan b closed loop leg product structure

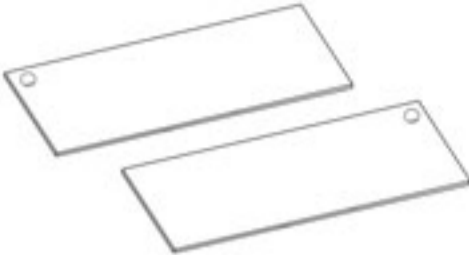

The Plan b benching system simplifies facilities management, by integrating and optimizing effectively with all types of floor spaces. The ease of assembly / disassembly of the product, facilitates hassle-free installations, and frequent re-configurations, and creates productive working environments. The Plan b benching system has an integrated cable management facility, that delivers convenient power and data to workstations. Power and data points can be located at workstation height, or just below, for easy access.

plan b closed loop leg product structure

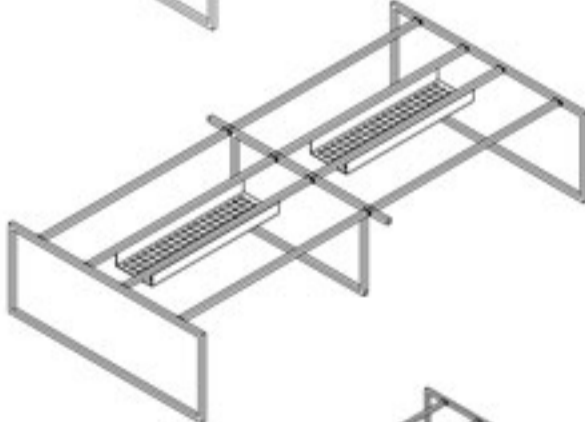
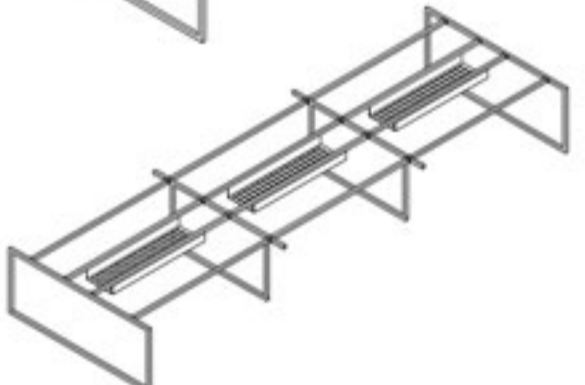
	description	size	code
	desk top for single and side by side workstations with one power cut out	2000(w) x 800(d)	
	desk top for single and side by side workstations with one power cut out	1800(w) x 800(d)	
	lhs plan b single desk structure closed loop leg structure including 2000(w) x 800(d) top with power cut out and power channel	2000(w) x 800(d)	2080LL
	rhs plan b single desk structure	2000(w) x 800(d)	2080LR
	lhs plan b single desk structure closed loop leg including 1800(w) x 800(d) - 22mm top with power cut out and power channel	1800(w) x 800(d)	1880LL
	rhs plan b single desk structure	1800(w) x 800(d)	1880LR
	plan b two way side by side desk structure closed loop leg structure including 2 x 1800/1600/1400/1200(w) - 22mm tops with 2 x power cut out and 2 x power channel	3600(w) x 800(d) 3200(w) x 800(d) 2800(w) x 800(d) 2400(w) x 800(d)	3680L 3280L 2880L 2480L
	desk top for cluster workstations with power slot	1800(w) x 800(d) 1600(w) x 800(d) 1400(w) x 800(d) 1200(w) x 800(d)	
	plan b 2 way desk structure closed loop leg structure including 2 x 1800/1600/1400/1200(w) x 800(d) - 22mm tops with 2 x power slots and 1 x power tray	1800(w) x 1600(d) 1600(w) x 1600(d) 1400(w) x 1600(d) 1200(w) x 1600(d)	1816L 1616L 1416L 1216L
	plan b 4 way desk structure closed loop leg structure including 4 x 1800/1600/1400/1200(w) x 800(d) - 22mm tops with 4 x power slots and 2 x power trays	3600(w) x 1600(d) 3200(w) x 1600(d) 2800(w) x 1600(d) 2400(w) x 1600(d)	3616L 3216L 2816L 2416L
	plan b 6 way desk structure closed loop leg structure including 6 x 1800/1600/1400/1200(w) x 800(d) - 22mm tops and 6 x power slots and 3 x power trays	5400(w) x 1600(d) 4800(w) x 1600(d) 4200(w) x 1600(d) 3600(w) x 1600(d)	5416L 4816L 4216L 3616L



plan b closed loop leg - mobile credenza with cushion





plan b closed loop leg - mobile pedestal with cushion



plan b closed loop leg - mobile credenza with cushion

description	size	code
	refer to product structure page for desk top sizes	
	1 250(w) x 500(d) x 630(h)	S700 C700
<p>mobile credenza - lhs with cushion and weight bearing castors 1S1F with drop in pen and pencil tray with plan b handles roller door available in silver and charcoal specify fabric and colour for cushion with order</p>		
	1 250(w) x 500(d) x 630(h)	S710 C710
<p>mobile credenza - rhs with cushion and weight bearing castors 1S1F with drop in pen and pencil tray with plan b handles includes shelf roller door available in silver and charcoal specify fabric and colour for cushion with order price includes all vulcan fabric colours note: refer to page for all internal components for credenzas</p>		

plan b closed loop leg - mobile pedestal with cushion

description	size	code
	refer to product structure page for desk top sizes	
	400(w) x 525(d) x 630(h)	610
<p>mobile pedestal with cushion and weight bearing castors 1S1F with drop in pen and pencil tray with plan b handles specify fabric and colour for cushion with order price includes all vulcan fabric colours</p>		

plan b closed loop leg - mobile pedestal



plan b closed loop leg - mobile pedestal with cushion and open top filer / pinboard



plan b closed loop leg - mobile pedestal



description

size

code

desk top
for cluster workstations with power slot

refer to product structure
page for desk top sizes



**mobile pedestal
1S1F**
with pull out pen &
pencil drawer and
plan b handles

400(w) x 525(d) x 590(h)

PB2010

plan b closed loop leg - mobile pedestal with cushion and top filer / pinboard



description

size

code

desk top
for cluster workstations with power slot

refer to product structure
page for desk top sizes

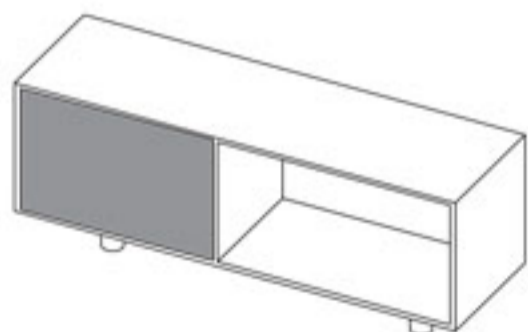

**two way open top filer
and pinboard**
with risers

1400(w) x 400(d) x 400(h)

800



**mobile pedestal
with cushion 3S**
with drop in pen and
pencil tray with plan b
handles

400(w) x 525(d) x 630(h)

630





specify fabric and colour for cushion with order
price includes all vulcan fabric colours

plan b angle leg product structure

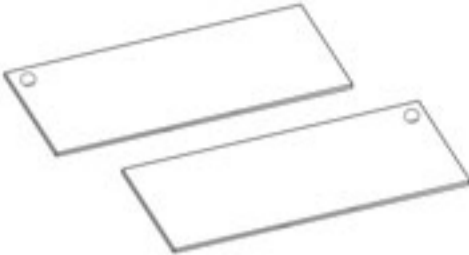

The Plan b benching system simplifies facilities management, by integrating and optimizing effectively with all types of floor spaces. The ease of assembly / disassembly of the product, facilitates hassle-free installations, and frequent re-configurations, and creates productive working environments. The Plan b benching system has an integrated cable management facility, that delivers convenient power and data to workstations. Power and data points can be located at workstation height, or just below, for easy access.

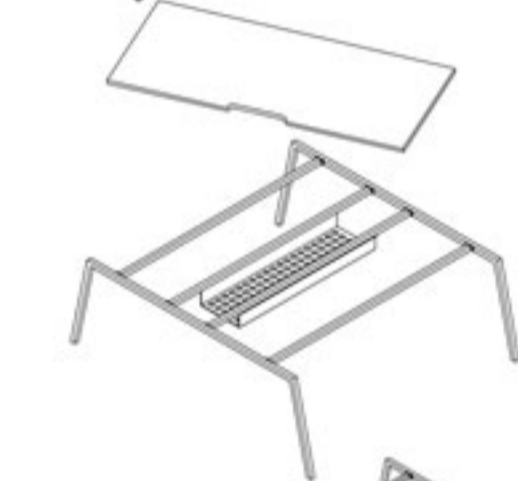
plan b angle leg product structure

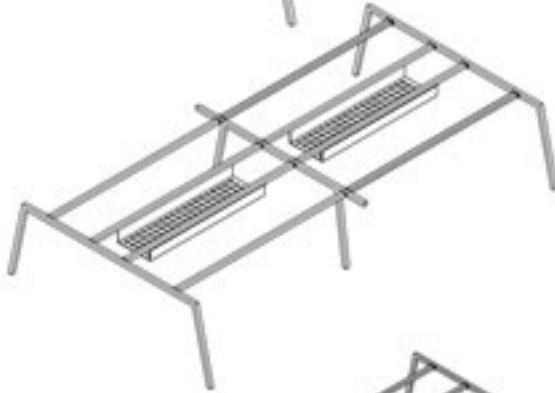
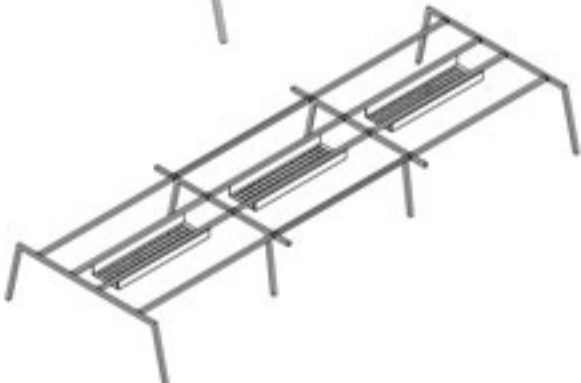
	description	size	code
	desk top for single and side by side workstations with one power cut out		
	desk top for single and side by side workstations with one power cut out	1800(w) x 800(d)	
	lhs plan b single desk structure angle leg structure including 2000(w) x 800(d) top - 22mm with power cut out and power channel	2000(w) x 800(d)	2080AL
	rhs plan b single desk structure	2000(w) x 800(d)	2080AR
	lhs plan b single desk structure angle leg structure including 1800(w) x 800(d) top - 22mm with power cut out and power channel	1800(w) x 800(d)	1880AL
	rhs plan b single desk structure	1800(w) x 800(d)	1880AR
	plan b two way side by side desk structure angle leg structure including 2 x 1800/ 1600/1400/1200(w) - 22mm tops with 2 x power cut out and 2 x power channel	3600(w) x 800(d) 3200(w) x 800(d) 2800(w) x 800(d) 2400(w) x 800(d)	3680A 3280A 2880A 2480A
	desk top for cluster workstations with power slot	1800(w) x 800(d) 1600(w) x 800(d) 1400(w) x 800(d) 1200(w) x 800(d)	
	plan b 2 way desk structure angle leg structure including 2 x 1800/1600/1400/1200(w) x 800(d) - 22mm tops and 1 power tray with 2 x power slots	1800(w) x 1600(d) 1600(w) x 1600(d) 1400(w) x 1600(d) 1200(w) x 1600(d)	1816A 1616A 1416A 1216A
	plan b 4 way desk structure angle leg structure including 4 x 1800/1600/1400/1200(w) x 800(d) - 22mm tops with 4 power slots and 2 power trays	3600(w) x 1600(d) 3200(w) x 1600(d) 2800(w) x 1600(d) 2400(w) x 1600(d)	3616A 3216A 2816A 2416A
	plan b 6 way desk structure angle leg structure including 6 x 1800/1600/1400/1200(w) x 800(d) - 22mm tops with 6 power slots and 3 power trays	5400(w) x 1600(d) 4800(w) x 1600(d) 4200(w) x 1600(d) 3600(w) x 1600(d)	5416A 4816A 4216A 3616A



plan b angle leg - hinge door lockers and mobile pedestals





plan b angle leg - hinge door lockers/open pigeon hole combo and mobile pedestals



plan b angle leg - hinge door lockers and mobile pedestals

	<u>description</u>	<u>size</u>	<u>code</u>
	desk top for cluster workstations with power slot	refer to angle leg product structure page for desk top sizes	
	mobile pedestal 1S1F with pull out pen and pencil drawer with plan b handles	400(w) x 525(d) x 590(h)	PB2010
	hinge door lockers with plan b handles	800(w) x 900(h) x 350(d)	810

plan b angle leg - hinge door lockers /open pigeon hole combo and mobile pedestals

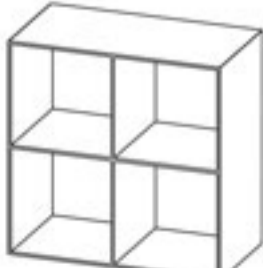
	<u>description</u>	<u>size</u>	<u>code</u>
	desk top for cluster workstations with power slot	refer to angle leg product structure page for desk top sizes	
	mobile pedestal 1S1F with drop in pen and pencil tray with plan b handles	400(w) x 525(d) x 590(h)	PB2009
	hinge door lockers with plan b handles	800(w) x 900(h) x 350(d)	810
	pigeon hole open cabinet	800(w) x 900(h) x 350(d)	820



plan b angle leg - open shelving cabinets/mobile pedestals





plan b angle leg - pigeon hole open cabinets/mobile pedestals

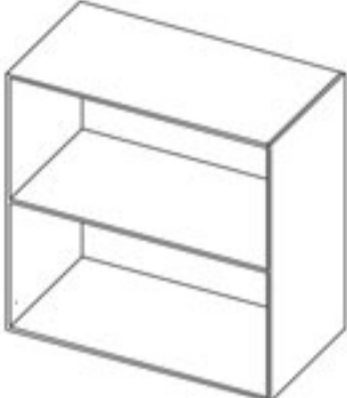

plan b angle leg - open shelving cabinets/mobile pedestals

	<u>description</u>	<u>size</u>	<u>code</u>
	desk top for cluster workstations with power slot	refer to angle leg product structure page for desk top sizes	
	mobile pedestal 3S with pull out pen and pencil drawer	400(w) x 525(d) x 590(h)	PB2008
	open storage unit two tier bookcase	800(w) x 900(h) x 400(d)	825

plan b angle leg - pigeon hole open cabinets/mobile pedestals

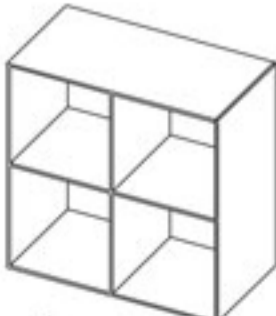
	<u>description</u>	<u>size</u>	<u>code</u>
	desk top for cluster workstations with power slot	refer to angle leg product structure page for desk top sizes	
	mobile pedestal 3S with drop in pen and pencil drawer	400(w) x 525(d) x 590(h)	PB2007
	pigeon hole open cabinet	800(w) x 900(h) x 400(d)	820



plan b straight leg manager workstation





plan b straight leg p.a workstation

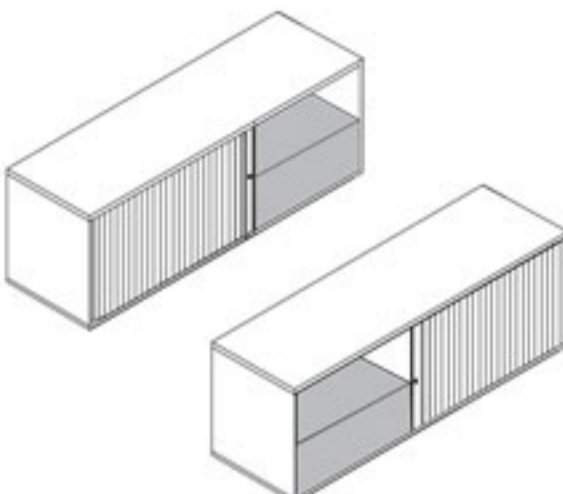

plan b straight leg manager workstation

	description	size	code
	work top - lhs including desk top - 32mm including plan b manager straight leg structure and modesty panel with assembly brackets and power cut out	2000(w) x 1000(d) 32mm modesty panel 1350(w) x 400(h) steel	8201 8201A
	work top - rhs	2000(w) x 1000(d) modesty panel 1350(w) x 400(h) steel	8202 8202B
	manager lhs roller door credenza with under desk laminate shelf and lever-arch file compartment roller door available in silver and charcoal	2000(w) x 500(d) x 715(h) 22mm top	S8203 C8203
	manager rhs roller door credenza with under desk laminate shelf and lever-arch file compartment roller door available in silver and charcoal	2000(w) x 500(d) x 715(h) 22mm top	S8204 C8204
	mobile pedestal 1S1F with drop in pen and pencil tray with plan b handles	400(w) x 525(d) x 590(h)	PB2009

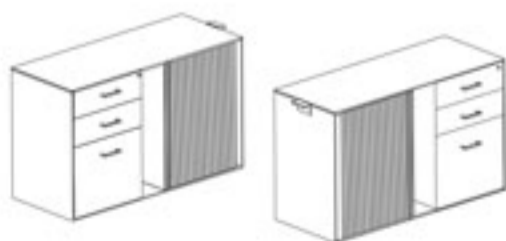
plan b straight leg p.a workstation

	description	size	code
	1800 work top - lhs desk top - 32mm including 2x plan b manager straight leg and beam system modesty panel with assembly brackets and power cut out	1800(w) x 800(d) 32mm modesty panel 1600(w) x 400(h) steel	8205 8205A
	1800 work top - rhs	1800(w) x 800(d) 32mm modesty panel 1600(w) x 400(h) steel	8205B 8205C
	2S1F pedenza - lhs storage bracket roller door available in silver and charcoal	1200(w) x 500(d) x 745(h) 32mm	PEDTFF1SL PEDTFF2CL
	2S1F pedenza - rhs storage bracket roller door available in silver and charcoal	1200(w) x 500(d) x 745(h) 32mm	PEDTFF1SR PEDTFF2CR
	mobile pedestal 1S1F with pull out pen and pencil tray with plan b handles	400(w) x 525(d) x 590(h)	PB2010



plan b closed loop leg manager workstation



plan b angle leg manager workstation

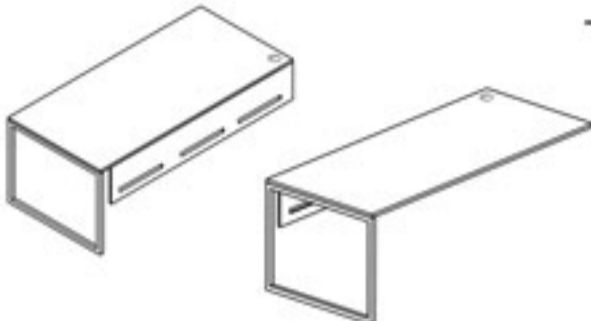
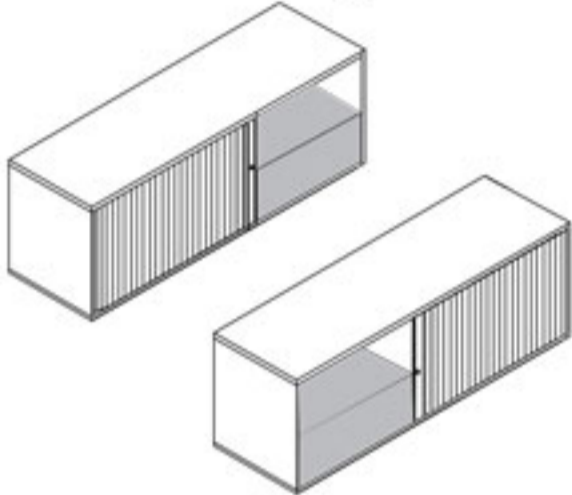

plan b closed loop leg manager workstation

	description	size	code
	work top - lhs including single desk top - 32mm including plan b manager closed loop leg and modesty panel with assembly brackets and power cut out	2000(w) x 1000(d) 32mm modesty panel 1350(w) x 400(h) steel	9201 9201A
	work top - rhs including single desk top - 32mm including plan b manager closed loop leg and modesty panel with assembly brackets and power cut out	2000(w) x 1000(d) 32mm modesty panel 1350(w) x 400(h) steel	9202 9202A
	manager lhs roller door credenza with under desk laminate shelf and lever-arch file compartment roller door available in silver and charcoal	2000(w) x 500(d) x 715(h) 22mm top	S8203 C8203
	manager rhs roller door credenza with under desk laminate shelf and lever-arch file compartment roller door available in silver and charcoal	2000(w) x 500(d) x 715(h) 22mm top	S8204 C8204
	mobile pedestal 3S with drop in pen and pencil drawer	400(w) x 525(d) x 590(h)	PB2007

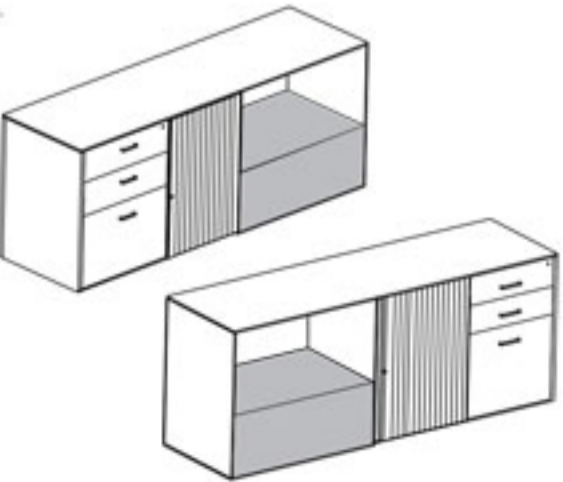

plan b angle leg manager workstation

	description	size	code
	work top - lhs including single desk top - 32mm including plan b manager angle leg and modesty panel with assembly brackets and power cut out	2000(w) x 1000(d) 32mm modesty panel 1350(w) x 400(h) steel	9203 9203A
	work top - rhs for single including single desk top - 32mm including plan b manager angle leg and modesty panel with assembly brackets and power cut out	2000(w) x 1000(d) 32mm modesty panel 1350(w) x 400(h) steel	9204 9204A
	roller door pedenza - lhs 2S1F with drop in pen and pencil drawer with under desk laminate shelf and lever-arch file compartment roller door available in silver and charcoal	2000(w) x 500(d) x 715(h) 22mm top	S9205 C9205
	roller door pedenza - rhs 2S1F with drop in pen and pencil drawer with under desk laminate shelf and lever-arch file compartment roller door available in silver and charcoal	2000(w) x 500(d) x 715(h) 22mm top	S9206 C9206

plan b cabinets and bookcase storage

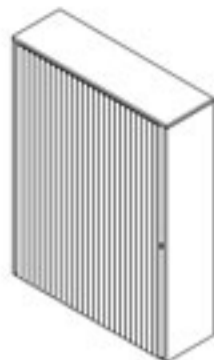
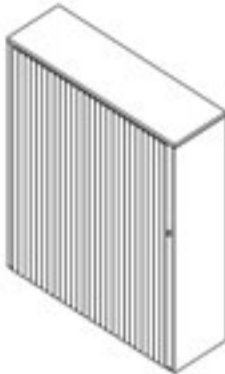

plan b - cabinets and bookcase storage

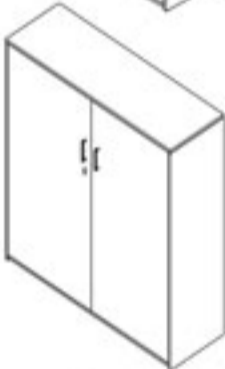
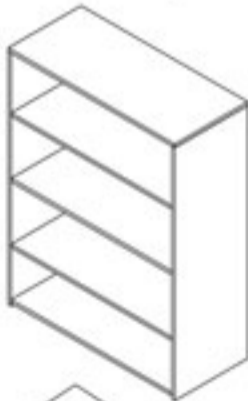
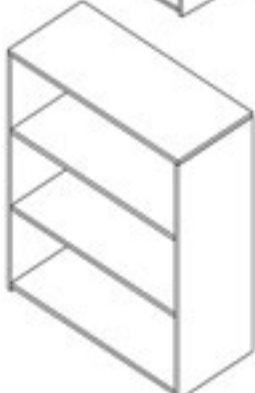
	<u>description</u>	<u>size</u>	<u>code</u>
	cabinet roller door roller door available in silver and charcoal	1800(h) x 1200(w) x 500(d)	S5077
		1800(h) x 1200(w) x 500(d)	C5077
		1500(h) x 1200(w) x 500(d)	S5007
		1500(h) x 1200(w) x 500(d)	C5007
		1500(h) x 900(w) x 500(d)	S5008
		1500(h) x 900(w) x 500(d) 22mm top and bottom	C5008
	cabinet roller door roller door available in silver and charcoal	1200(h) x 1200(w) x 500(d)	S5108
		1200(h) x 1200(w) x 500(d)	C5108
		1200(h) x 900(w) x 500(d)	S5118
		1200(h) x 900(w) x 500(d)	C5118
		22mm top and bottom	
	cabinet hinge door plan b handles	1800(h) x 1100(w) x 500(d)	PB5009C
		1800(h) x 900(w) x 500(d)	PB5009B
		1500(h) x 1100(w) x 500(d)	PB5009A
		1500(h) x 900(w) x 500(d)	PB5009D
		22mm top and bottom	
	cabinet hinge door plan b handles	1200(h) x 1100(w) x 500(d)	PB5010
		1200(h) x 900(w) x 500(d)	PB5010A
		22mm top and bottom	
	note: refer to page	for all internal components for cabinets	
	bookcase with 3 x laminate shelf including 22mm shelves	1500(h) x 1100(w) x 350(d)	PB5011
		1500(h) x 900(w) x 350(d)	PB5011A
		22mm top and bottom	
	bookcase with 2 x laminate shelf including 22mm shelves	1200(h) x 1100(w) x 350(d)	PB5012
		1200(h) x 900(w) x 350(d)	PB5012A
		22mm top and bottom	



in the office
FURNITURE

MAKE YOUR WORKPLACE A HAPPY SPACE

Contact Adel on 063 246 2997 or Michael on 083 627 8203
adel@itofurniture.co.za or michael@itofurniture.co.za
www.itofurniture.co.za